



**HUNTER**  
**COMPOSITE DECKING  
INSTALLATION GUIDE**







## RECOMMENDED SAFETY EQUIPMENT

## HUNTER DECKING SYSTEM COMPONENTS

		
Deck Board	Edging Board	Starter Clip
		
Universal Clip	Fascia	Screws

## TOOLS REQUIRED FOR INSTALLATION

We recommend using Carbide tipped blades and 40-50 teeth saw blades

		
Circular Saw	Power Drill	Tape Measure & Pencil
		
Rubber Mallet	Spirit Level	Jigsaw

		
Ear Protection	Safety Glasses	Gloves
		
Dust Mask	Safety Footwear	Long Sleeves

## HOW MUCH PRODUCT DO I NEED?

### HUNTER DECK BOARDS:

- In metres, multiply the length by the width of the area; Length(m) x Width(m) = (a)
- Multiply the answer (a) by 2.
- If there is a decimal, round it up to the next number.

Example based on an area of 3.6m length by 4.8m wide:

$3.6 \times 4.8 = 17.28 \times 2 = 34.56$ . Rounded up to nearest full board = 35 boards required.

### STARTER CLIPS:

- In millimetres (mm), measure the total length of the boards with the grooved side facing you = (a)
- Divide the answer (a) by 300
- Add 1 to the answer

Example based on 3600mm

$3600 / 300 = 12$

$12 + 1 = 13$

**HUNTER UNIVERSAL CLIPS:** 13 per board.

### HUNTER EDGING BOARD AND FASCIAS:

As required subject to the design of the deck.

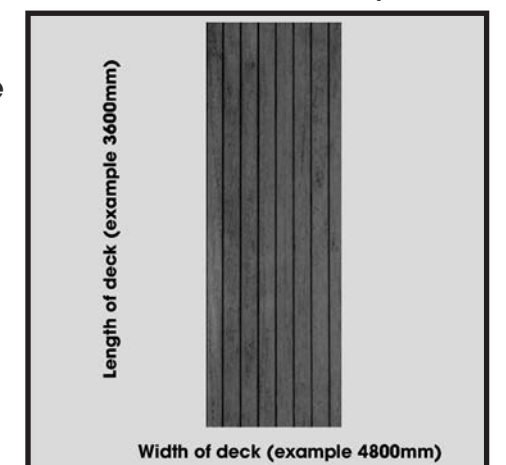



## TIMBER SUBFRAME CONSIDERATIONS

- C16 treated timber should be used for constructing the subframe.
- Recommended sizes: 100 x 47mm or if elevated 125 x 47mm.
- We recommend 300mm joist centres.
- A 15mm gap should be left between the frame and any walls to allow for air flow.
- We recommend covering the ground underneath the frame with a membrane to prevent weeds from coming through.
- Always use screws suitable for outdoor use when constructing the frame.

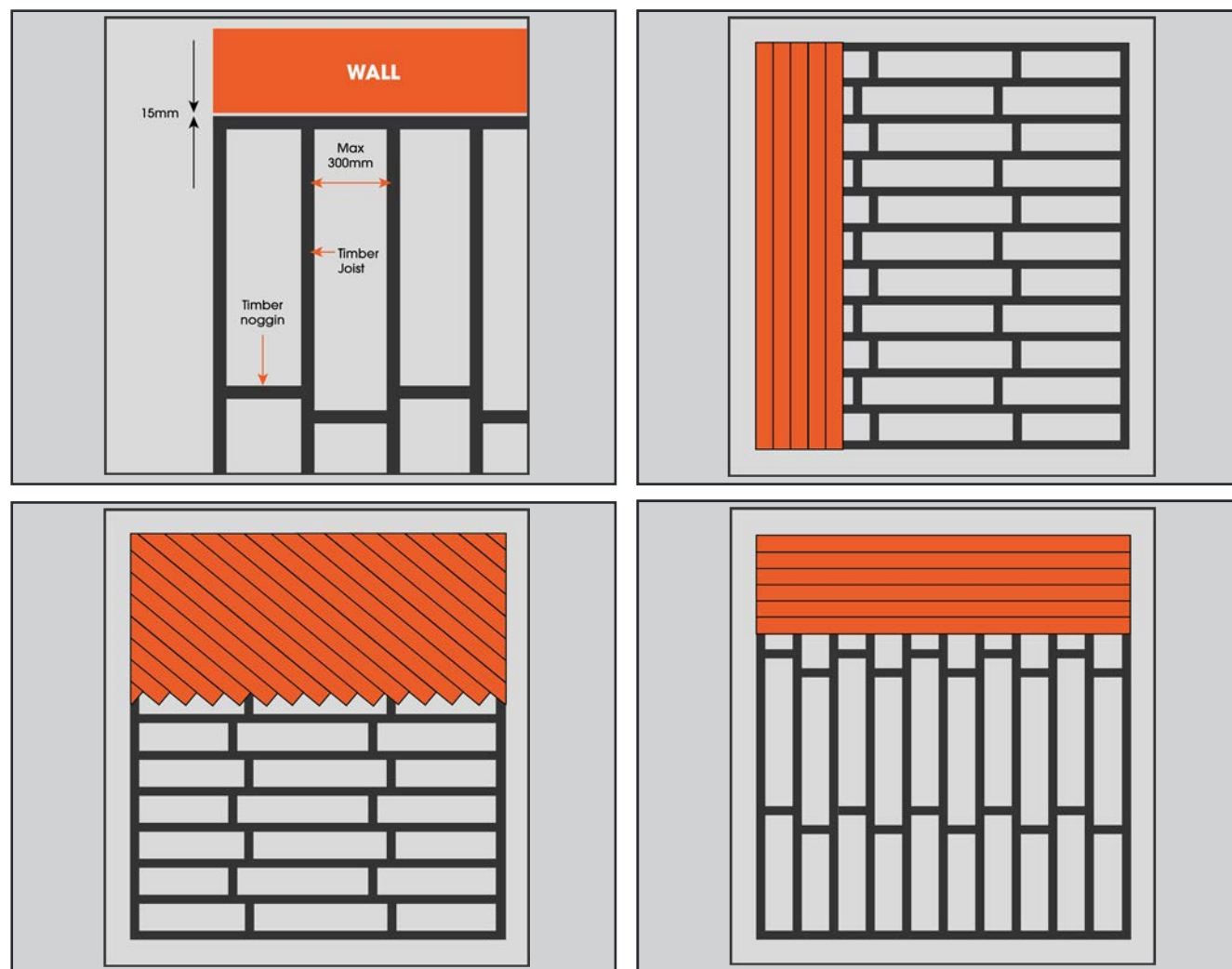

## PRE INSTALLATION CONSIDERATION

Always purchase all the boards for the project together as colour may vary from batch to batch.

Always inspect the boards for any damage upon delivery.

Always allow for wastage (10% is recommended subject to design).

## INSTALLATION CONSIDERATIONS

All composite decking boards will naturally contract and expand, subject to temperature conditions.

Suitable gaps should be maintained between board joints. This is outlined in the adjacent table.

It is recommended to allow composite boards to acclimatise to the outside temperature for a 24 hour period prior to installation.

TEMPERATURE GUIDANCE TABLE	
Outside Temperature	End-To-End Gap
Below 4°C	6mm
Between 4°C - 25°C	3mm

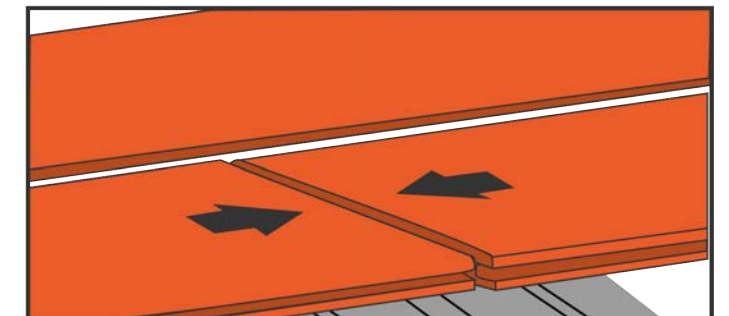

## HANDLING CONSIDERATIONS

When storing the boards outside always put the boards on a flat surface and cover them with a layer of sheeting to protect them from dirt and grit that could damage the boards. Do not drag or slide the boards over one another when laying the deck.

## INSTALLING THE LAST DECK BOARD

## INSTALLING THE HUNTER DECK BOARDS

1. Position the starter clips at the intersection of each joist and secure. These should be level with the edge of the frame. (Fig. A)
2. Place the deck board with the grooved edge facing the starter clips. (Fig. B)
3. Insert the deck board into the starter clip at a slight angle before pushing into place. (Fig. C)
4. Place HUNTER universal clips on each joist and into the side groove of the board. Using the screw provided, secure the clip. Do not tighten them up. (Fig. D + E)
5. Line up the next board with the clips and push it into place. Now tighten the first row of clips. (Fig. F)
6. Repeat the process for subsequent boards.

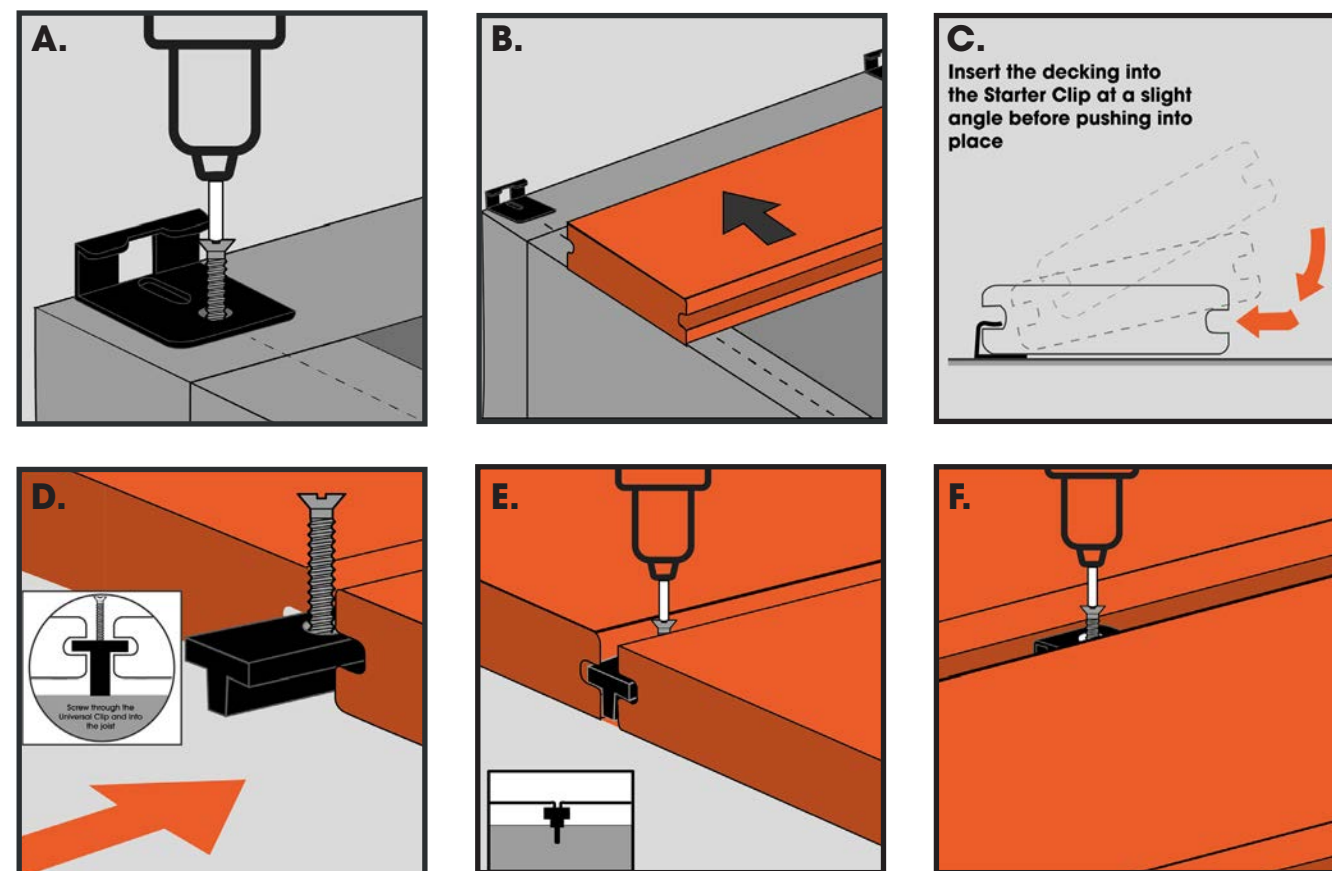

1. To fit the last board, first measure the width of the final board. Trim the board to size, if required.
2. Do not fit the penultimate board yet.
3. Fit starter clips and slot the last board in place. (Fig. A + B)
4. Now insert the penultimate board.
5. Slide the required HUNTER universal clips in between the boards. (Fig. C)
6. Once the clips are positioned over the joists, secure in place. (Fig. D)

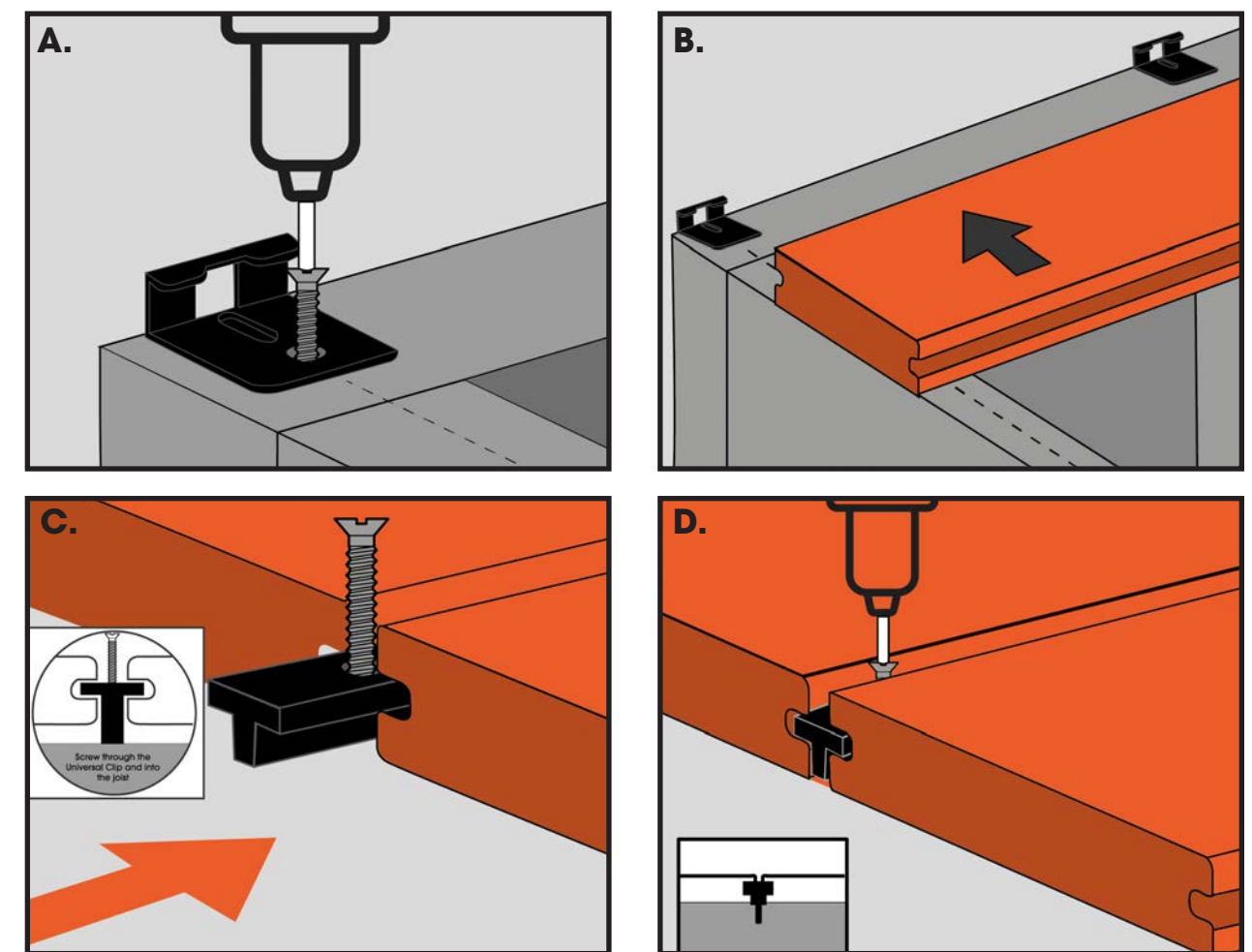



## INSTALLING THE HUNTER EDGING BOARD

1. Position and fit the starter clips as described in the previous section.
2. Place the HUNTER edging board over the starter clip and push the board (as shown in the diagram) to secure in place (Fig. A, Fig. B).
3. Continue fitting the rest of the boards as previously described.
4. This will give you a 35mm overhang less the thickness of the fascia used.
5. If you are fitting the HUNTER edging board perpendicular to the rest of the boards you will need a double joist on your frame (see section "Picture framing").
6. To secure the HUNTER edging board perpendicular to the rest of the boards, you will need to use the FUZION universal metal clip and trim off, or flatten, the two side tabs on the clip as shown in the diagram (Fig. C).

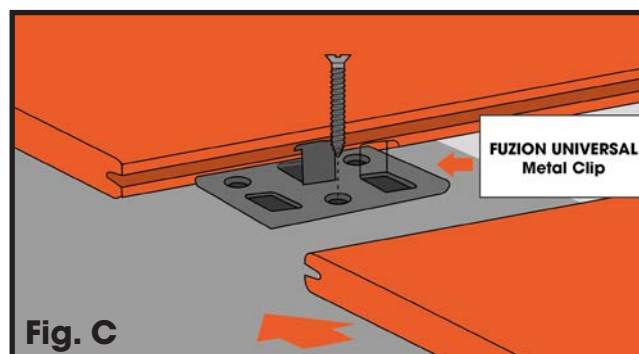
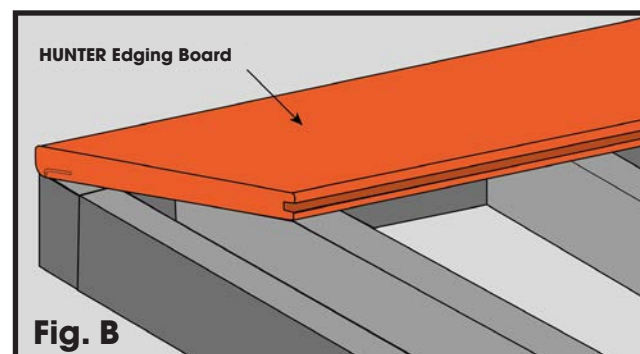
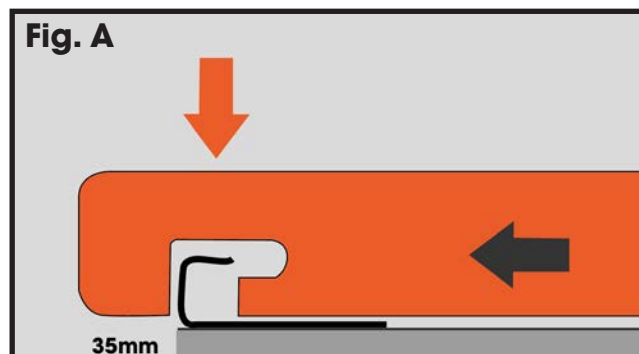

## PICTURE FRAMING

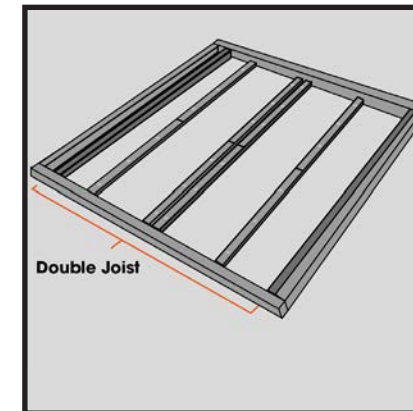

A double joist is needed on the perpendicular side of the frame.

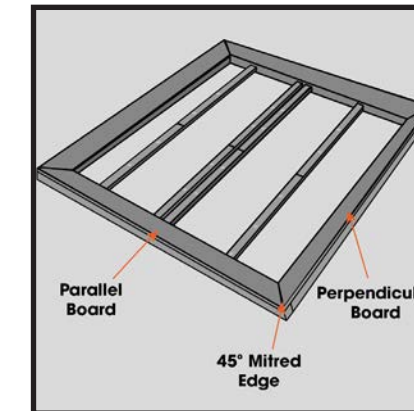

Boards will need to be cut with 45 degree mitred edges.

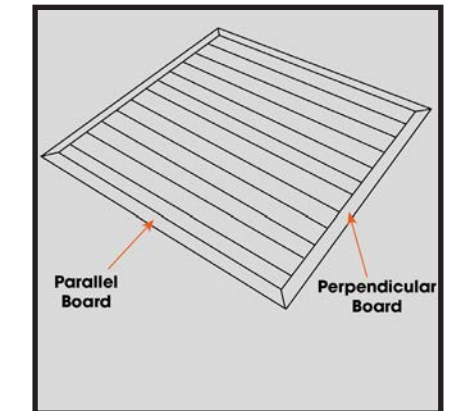

After installing the perimeter boards, install subsequent boards.

## INSTALLATION CONSIDERATIONS

Deck board edges can be finished with a fascia trim.

Run some grip adhesive on the back of the trim and secure in place by either using panel pins or screws.

Always pre drill pilot holes in the fascia.

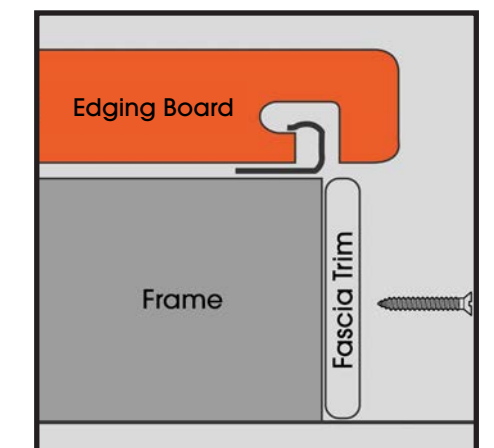
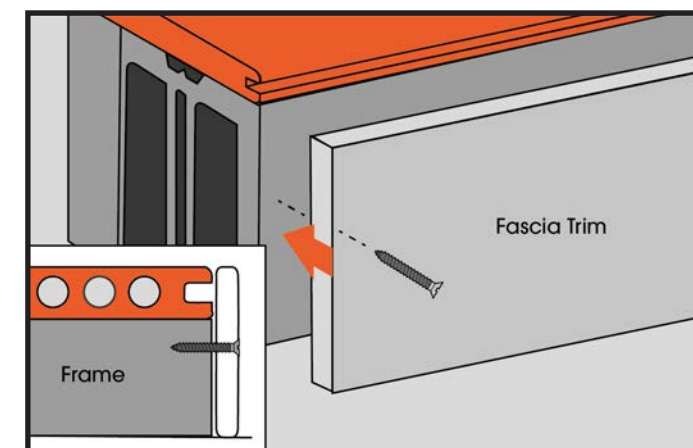



## CARING FOR YOUR HUNTER DECK

### BUILDING DECKING STEPS

- Steps can be made by building a number of boxes and stacking them on top of each other.
- The thread height (including the deck board) should be a maximum of 150mm.
- Joists centres - 300mm.
- Secure the steps to the subframe.

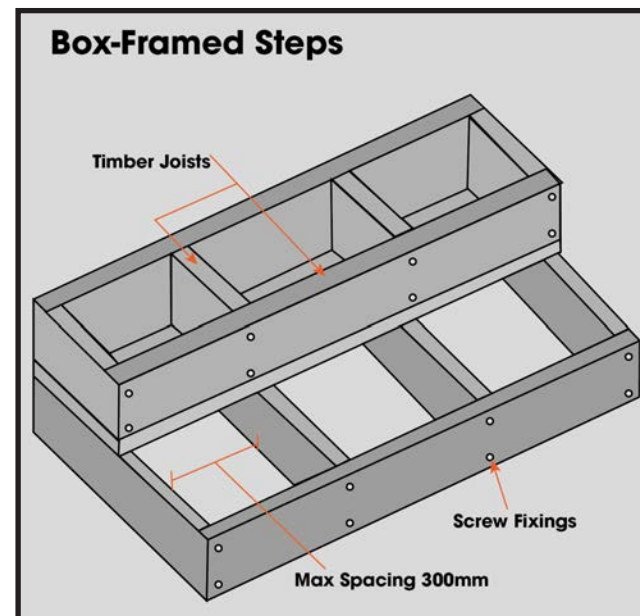

Steps using HUNTER deck boards and fascia boards

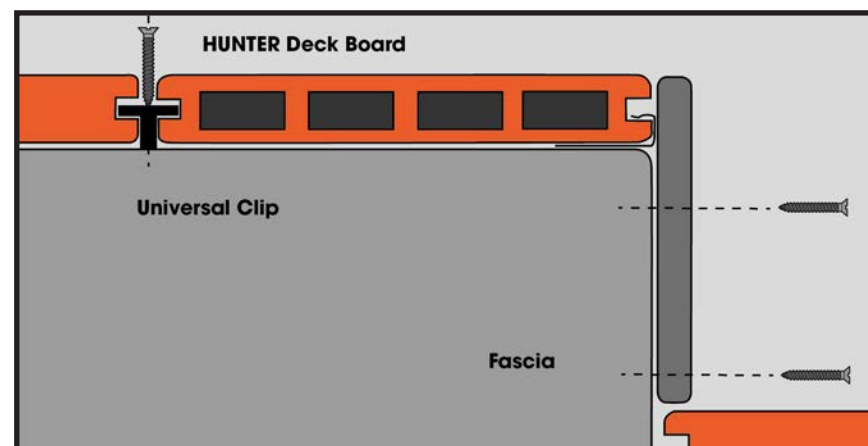

Steps using HUNTER edging boards and fascia boards

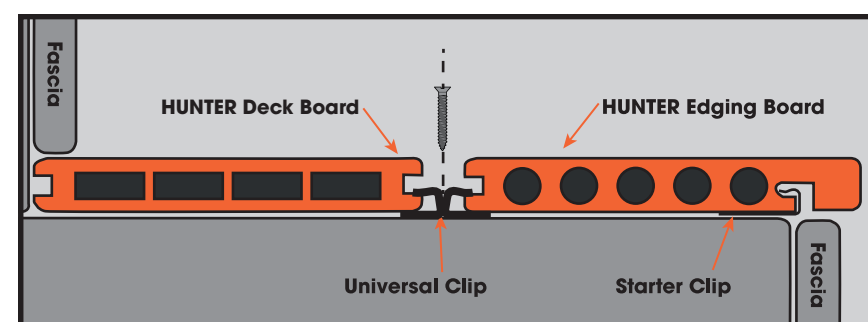

We recommend cleaning your deck every 3-6 months.

**General Cleaning** - Apply warm soapy water to the surface of the boards and clean with a soft bristled brush.

**Deep Cleaning** - Use PAVETUF COMPOSITE CLEANER which is specifically designed for the removal of built up surface dirt. It is biodegradable and is a non-acidic, non-caustic formula. Alternatively use a jet wash with no greater than 3100 PSI to clean the surface of your deck.

Regardless of which cleaning method you choose, always clean along the length of the boards to prevent any accumulation of debris that can interfere with water drainage.

#### Stubborn Spot Stains

For stubborn stains, such as oil and grease marks, we recommend that you use the techniques outlined above as well as the advice below:

Treat the affected area within the first 7 days.

PAVETUF DEEP CLEANER can be used, as it contains a degreasing agent which assists in the removal of heavy soiling such as oil and grease stains from the surface of hard landscaping products, including composite deck boards.

#### Surface Mildew and Mould Growth

Piranha deck boards are resistant to the damaging effects of both mould and mildew growth, this type of growth can occur on almost every outdoor surface and may collect on the surface of the boards. General routine cleaning will help avoid excessive build-up of such growth. PAVETUF GREEN-OFF can be used if there is a build-up of organic growth. It is a fast acting cleaner specifically designed for the treatment of organic growth.

#### Water Stains

Use warm soapy water to thoroughly clean the affected boards. You may want to use a jet wash on the affected area to assist with the removal of surface residue. To further speed-up this process, use PAVETUF COMPOSITE CLEANER.

#### Ice and Snow

Avoid using metal shovels, rakes, ice chippers and any other sharp objects to clear snow or ice off your deck. We recommend using a plastic shovel, otherwise you run the risk of scratching or damaging the surface of the boards.

We recommend using a salt-free, non-corrosive ice melt which is designed not to leave any residue on the surface of the boards and is generally more effective than salt-based alternatives.

Rock salt can be used on our composite decking, but we advise that this is cleared away shortly after it has been applied to ensure that it does not damage or scratch the surface of the boards.



# Welcome to **TALASEY**

YOUR ONE STOP SHOP FOR LANDSCAPING PRODUCTS

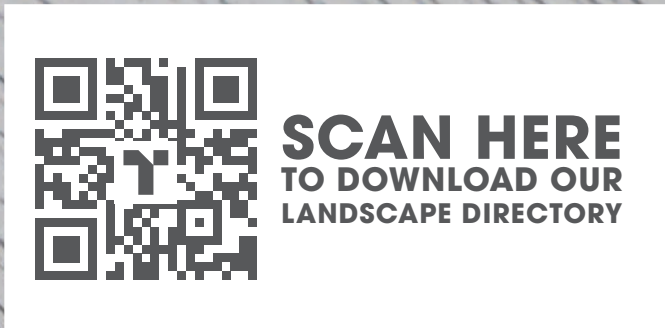

See website for terms & conditions  
info@talasey.co.uk  
0330 333 8030  
[www.talasey.co.uk](http://www.talasey.co.uk)

  
**TALASEY**  
GROUP