

SYSTEM TOP FIXED WITH HANDRAIL INSTALLATION INSTRUCTIONS INSTALL POSTS

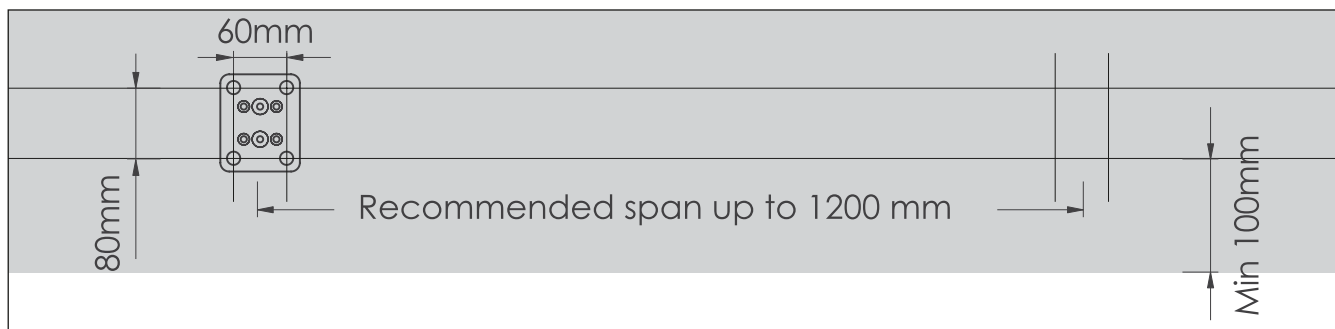

Posts should be a minimum of 100mm from the edge of the concrete with a recommended span up to 1200mm. When using standard 10mm glass you will have approximately 13mm between post centre and glass for ease of installation.



Drill holes & fit the rods.



Tighten nuts to fit the posts.

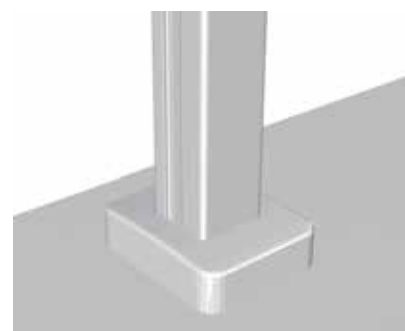

Fit the covers.

FITTING GLASS

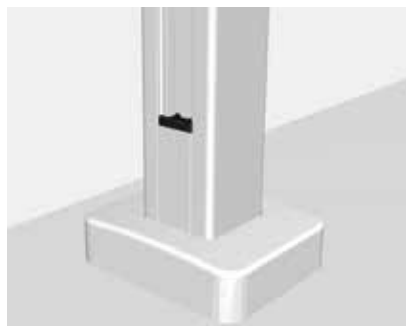

Fit the bottom infill & plastic packing block.



Fit back rubber in from the side.



Slide glass in from the top between posts.



Fit glass retaining rubber
(Roller assisted, spray soapy water as lubricant).

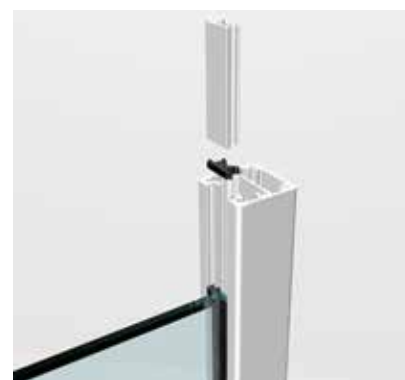

Fit the plastic packing block & infill on the top of glass.

FITTING HANDRAIL

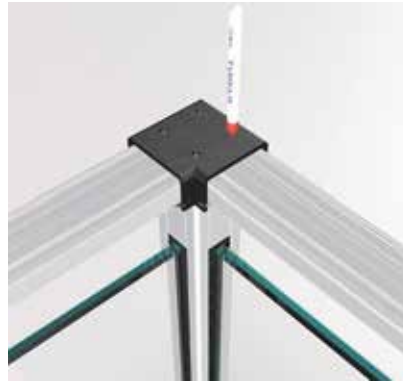

Place under cap in position & using drilling jig mark holes for drilling & drill holes.



Place wall bracket in position & mark holes for drilling & drill holes.

Tighten the screws to fit under cap to posts & fit wall bracket to the wall.

Slide handrail on & push down to clip into place.



Whilst every effort has been made to ensure the accuracy of the information supplied, Ecoscape UK cannot be held responsible for any errors or omissions. This product must only be employed for its original intended use. Any other use is wrong and potentially dangerous. Installation must be carried out in full compliance with current regulations. Ecoscape UK cannot be held liable for any damages resulting from wrongful, erroneous or negligent use.

Jul 2021

SYSTEM SIDE FIXED WITH HANDRAIL INSTALLATION INSTRUCTIONS INSTALL POSTS

INSTALL POSTS

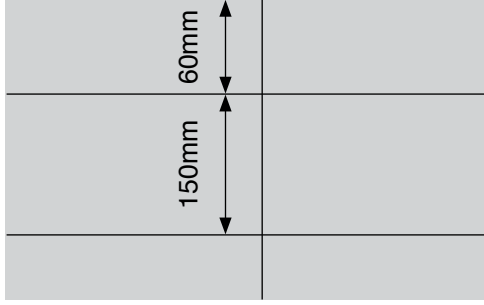

1. Mark a level line about 60mm down from the top edge.
2. Mark a second line about 150mm down from the first line.
3. Mark out post centres and drill holes.



4. Insert threaded rods.

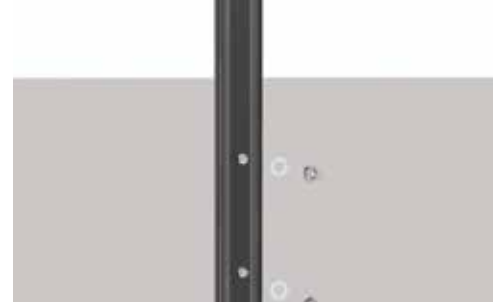

5. Install post and tighten washers & nut.

FITTING GLASS



1. Fit infill and plastic packing block.



2. Fit captive rubber on the outside of the post.

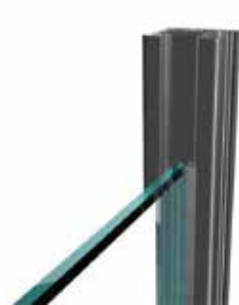

3. Slide glass in from the top.



4. Fit packer rubber (roller assisted, spray soapy water as lubricant).



5. Fit the plastic packing block and infill on the top of glass.



6. Fit side cover in the post.

FITTING HANDRAIL



1. Place under cap in position and use drilling jig to mark holes.

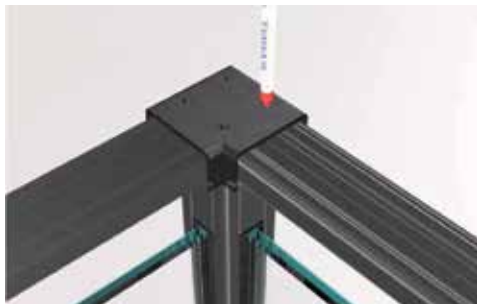

2. Drill holes.

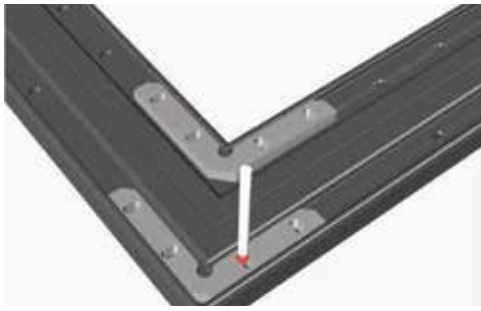

4. Position connector on under cap.

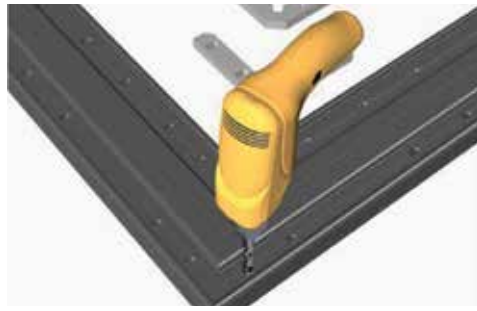

5. Drill holes.

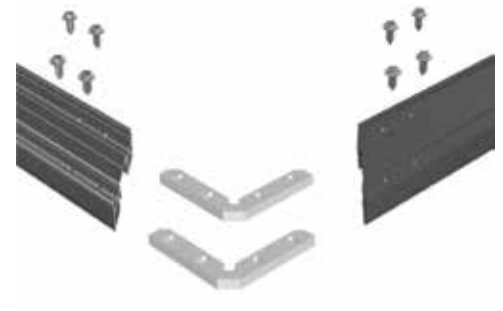

6. Screw down.

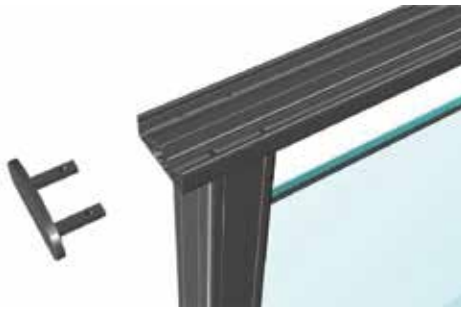

7. Fix end cap to the end of handrail.

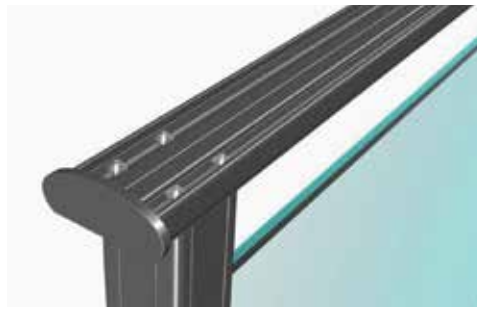

8. Place under cap back and screw down.

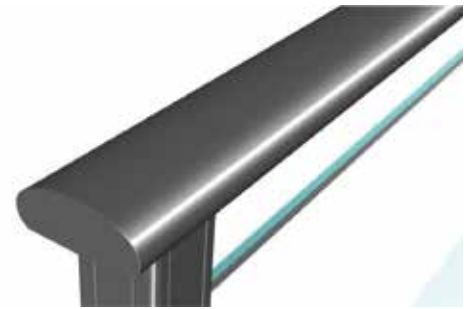

9. Slide handrail on, push down to clip into place.

FULL VIEW AFTER INSTALLATION



Whilst every effort has been made to ensure the accuracy of the information supplied. Ecoscape UK cannot be held responsible for any errors or omissions. This product must only be employed for its original intended use. Any other use is wrong and potentially dangerous. Installation must be carried out in full compliance with current regulations. Ecoscape UK cannot be held liable for any damages resulting from wrongful, erroneous or negligent use.

Jul 2021